

SOT-23 Plastic-Encapsulate MOSFETS

BC3400 N-Channel Enhancement Mode Field Effect Transistor

FEATURE

- High dense cell design for extremely low $R_{DS(ON)}$
- Exceptional on-resistance and maximum DC current capability

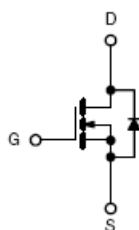

Equivalent Circuit

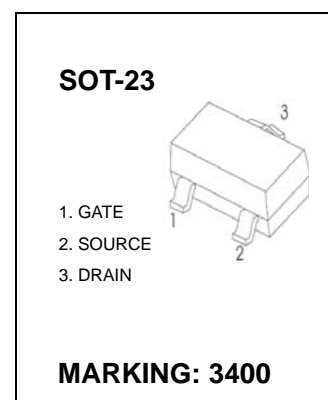

Maximum ratings ($T_a=25^{\circ}\text{C}$ unless otherwise noted)

Parameter	Symbol	Value	Unit
Drain-Source Voltage	V_{DS}	30	V
Gate-Source Voltage	V_{GS}	± 12	V
Continuous Drain Current	I_D	5.8	A
Drain Current-Pulsed (note 1)	I_{DM}	30	A
Power Dissipation	P_D	350	mW
Thermal Resistance from Junction to Ambient (note 2)	$R_{\theta JA}$	357	$^{\circ}\text{C}/\text{W}$
Junction Temperature	T_J	150	$^{\circ}\text{C}$
Storage Temperature	T_{STG}	-55~+150	$^{\circ}\text{C}$

Electrical characteristics (T_a=25°C unless otherwise noted)

Parameter	Symbol	Test Condition	Min	Typ	Max	Units
Off Characteristics						
Drain-source breakdown voltage	V _{(BR) DSS}	V _{GS} = 0V, I _D = 250μA	30			V
Zero gate voltage drain current	I _{DSS}	V _{DS} = 24V, V _{GS} = 0V			1	μA
Gate-source leakage current	I _{GSS}	V _{GS} = ±12V, V _{DS} = 0V			±100	nA
On characteristics						
Drain-source on-resistance (note 3)	R _{DS(on)}	V _{GS} = 10V, I _D = 5.8A			35	mΩ
		V _{GS} = 4.5V, I _D = 5A			40	mΩ
Forward tranconductance	g _{FS}	V _{DS} = 5V, I _D = 5A	8			S
Gate threshold voltage	V _{GS(th)}	V _{DS} = V _{GS} , I _D = 250μA	0.7		1.4	V
Dynamic Characteristics (note 4,5)						
Input capacitance	C _{iss}	V _{DS} = 15V, V _{GS} = 0V, f = 1MHz			1050	pF
Output capacitance	C _{oss}			99		pF
Reverse transfer capacitance	C _{rss}			77		pF
Gate resistance	R _g	V _{DS} = 0V, V _{GS} = 0V, f = 1MHz			3.6	Ω
Switching Characteristics (note 4,5)						
Turn-on delay time	t _{d(on)}	V _{GS} = 10V, V _{DS} = 15V, R _L = 2.7Ω, R _{GEN} = 3Ω			5	ns
Turn-on rise time	t _r				7	ns
Turn-off delay time	t _{d(off)}				40	ns
Turn-off fall time	t _f				6	ns
Drain-source diode characteristics and maximum ratings						
Diode forward voltage (note 3)	V _{SD}	I _S = 1A, V _{GS} = 0V			1	V

Note :

1. Repetitive Rating : Pulse width limited by maximum junction temperature.
2. Surface Mounted on FR4 Board, t < 5 sec.
3. Pulse Test : Pulse Width ≤ 300μs, Duty Cycle ≤ 2%.
4. Guaranteed by design, not subject to production testing.

Typical Characteristics

Output Characteristics

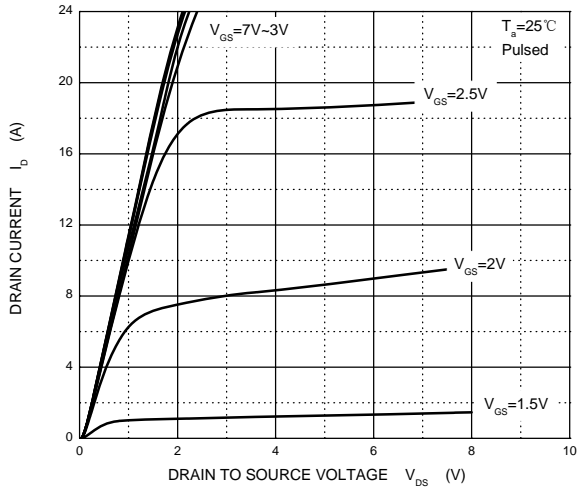

Transfer Characteristics

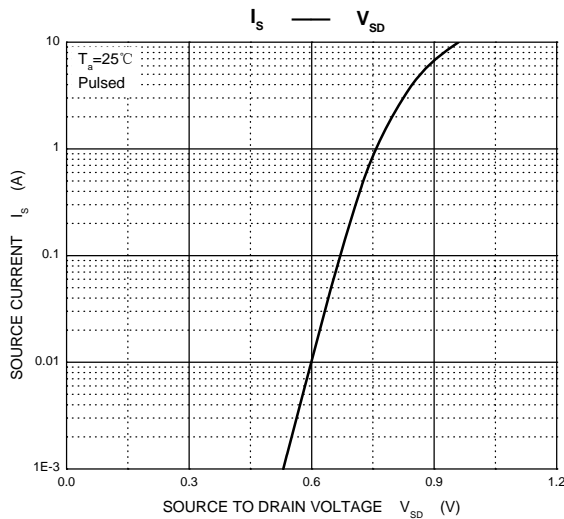
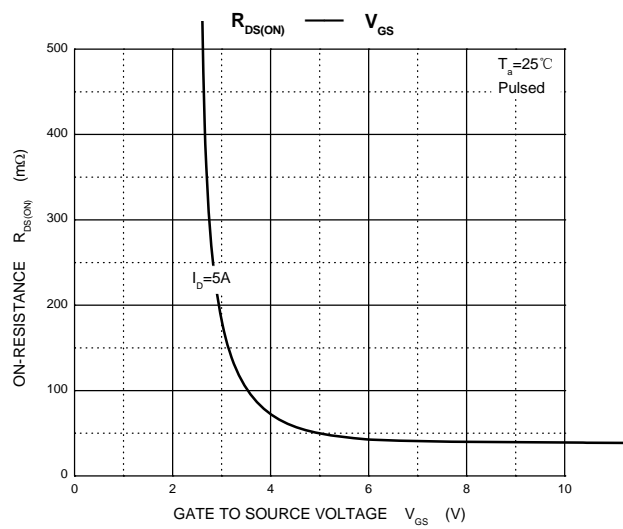
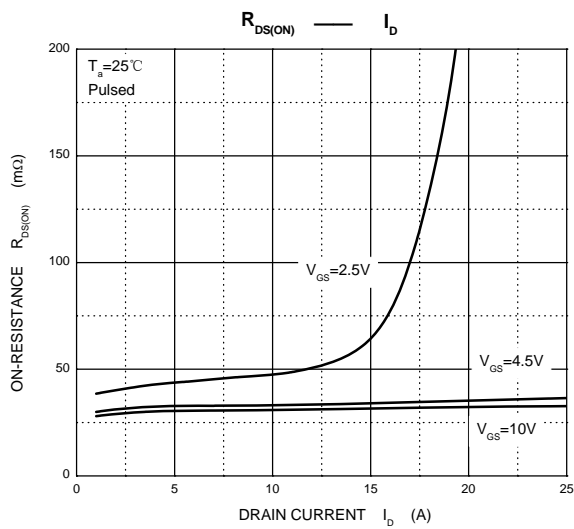
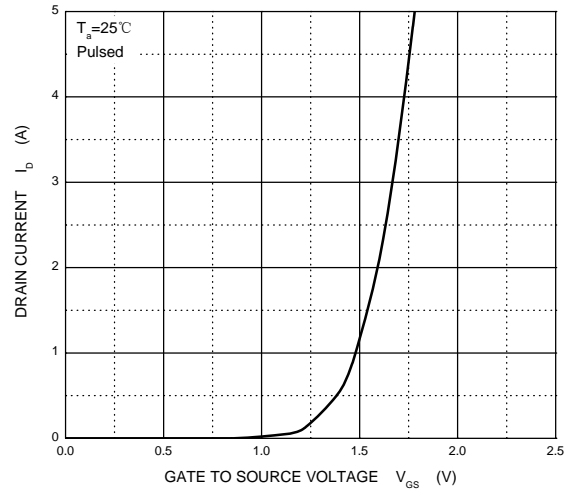

PACKAGE OUTLINE

Plastic surface mounted package; 3 leads

SOT-23

